

Cool MOS™ Power Transistor
Feature

- New revolutionary high voltage technology
- Ultra low gate charge
- Extreme dv/dt rated
- Ultra low effective capacitances
- Improved transconductance
- Qualified according to JEDEC⁰⁾ for target applications

V_{DS}	600	V
$R_{DS(on)}$	3	Ω
I_D	0.4	A

SOT-223

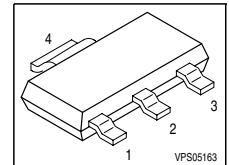

Type	Package	Ordering Code	Marking
SPN02N60S5	SOT-223	Q67040-S4207	02N60S5

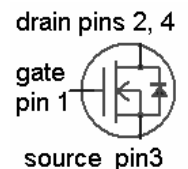
Maximum Ratings

Parameter	Symbol	Value	Unit
Continuous drain current $T_A = 25\text{ °C}$ $T_A = 70\text{ °C}$	I_D	0.4 0.3	A
Pulsed drain current, t_p limited by T_{jmax} $T_A = 25\text{ °C}$	I_D puls	2.2	
Gate source voltage	V_{GS}	± 20	V
Gate source voltage AC ($f > 1\text{Hz}$)	V_{GS}	± 30	
Power dissipation, $T_A = 25\text{ °C}$	P_{tot}	1.8	W
Operating and storage temperature	T_j, T_{stg}	-55... +150	$^{\circ}\text{C}$

Maximum Ratings

Parameter	Symbol	Value	Unit
Drain Source voltage slope $V_{DS} = 480 \text{ V}$, $I_D = 1.8 \text{ A}$, $T_j = 125 \text{ }^\circ\text{C}$	dv/dt	20	V/ns

Thermal Characteristics

Parameter	Symbol	Values			Unit
		min.	typ.	max.	
Thermal resistance, junction - soldering point	R_{thJS}	-	30	-	K/W
SMD version, device on PCB: @ min. footprint @ 6 cm ² cooling area ¹⁾	R_{thJA}	-	110	--	
		-	-	70	
Soldering temperature, 1.6 mm (0.063 in.) from case for 10s	T_{sold}	-	-	260	$^\circ\text{C}$

Electrical Characteristics, at $T_j=25^\circ\text{C}$ unless otherwise specified

Parameter	Symbol	Conditions	Values			Unit
			min.	typ.	max.	
Drain-source breakdown voltage	$V_{(BR)DSS}$	$V_{GS}=0\text{V}$, $I_D=0.25\text{mA}$	600	-	-	V
Drain-Source avalanche breakdown voltage	$V_{(BR)DS}$	$V_{GS}=0\text{V}$, $I_D=1.8\text{A}$	-	700	-	μA
Gate threshold voltage	$V_{GS(th)}$	$I_D=80\mu\text{A}$, $V_{GS}=V_{DS}$	3.5	4.5	5.5	
Zero gate voltage drain current	I_{DSS}	$V_{DS}=600\text{V}$, $V_{GS}=0\text{V}$, $T_j=25^\circ\text{C}$, $T_j=150^\circ\text{C}$	-	0.5	1	
Gate-source leakage current	I_{GSS}	$V_{GS}=20\text{V}$, $V_{DS}=0\text{V}$	-	-	100	nA
Drain-source on-state resistance	$R_{DS(on)}$	$V_{GS}=10\text{V}$, $I_D=1.1\text{A}$, $T_j=25^\circ\text{C}$ $T_j=150^\circ\text{C}$	-	2.5	3	Ω
			-	6.8	-	

Electrical Characteristics , at $T_j = 25\text{ }^\circ\text{C}$, unless otherwise specified

Parameter	Symbol	Conditions	Values			Unit
			min.	typ.	max.	
Characteristics						
Transconductance	g_{fs}	$V_{DS} \geq 2 \cdot I_D \cdot R_{DS(on)max}$, $I_D = 0.3\text{A}$	-	0.5	-	S
Input capacitance	C_{iss}	$V_{GS} = 0\text{V}$, $V_{DS} = 25\text{V}$, $f = 1\text{MHz}$	-	250	-	pF
Output capacitance	C_{oss}		-	110	-	
Reverse transfer capacitance	C_{rss}		-	8	-	
Turn-on delay time	$t_{d(on)}$	$V_{DD} = 350\text{V}$, $V_{GS} = 0/10\text{V}$, $I_D = 0.4\text{A}$, $R_G = 50\Omega$	-	30	-	ns
Rise time	t_r		-	15	-	
Turn-off delay time	$t_{d(off)}$		-	110	-	
Fall time	t_f		-	30	-	

Gate Charge Characteristics

Gate to source charge	Q_{gs}	$V_{DD} = 350\text{V}$, $I_D = 0.4\text{A}$	-	1.8	-	nC
Gate to drain charge	Q_{gd}		-	4.5	-	
Gate charge total	Q_g	$V_{DD} = 350\text{V}$, $I_D = 0.4\text{A}$, $V_{GS} = 0\text{ to }10\text{V}$	-	7.4	-	
Gate plateau voltage	$V_{(plateau)}$	$V_{DD} = 350\text{V}$, $I_D = 0.4\text{A}$	-	8	-	V

⁰J-STD20 and JESD22

¹Device on 40mm*40mm*1.5mm epoxy PCB FR4 with 6cm² (one layer, 70 μm thick) copper area for drain connection. PCB is vertical without blown air.

Electrical Characteristics, at $T_j = 25\text{ °C}$, unless otherwise specified

Parameter	Symbol	Conditions	Values			Unit
			min.	typ.	max.	
Inverse diode continuous forward current	I_S	$T_A=25\text{ °C}$	-	-	0.4	A
Inverse diode direct current, pulsed	I_{SM}		-	-	2.2	
Inverse diode forward voltage	V_{SD}	$V_{GS}=0V, I_F=I_S$	-	0.85	1.05	V
Reverse recovery time	t_{rr}	$V_R=350V, I_F=I_S,$	-	200	-	ns
Reverse recovery charge	Q_{rr}	$di_F/dt=100A/\mu s$	-	0.7	-	μC

1 Power dissipation

$P_{tot} = f(T_A)$

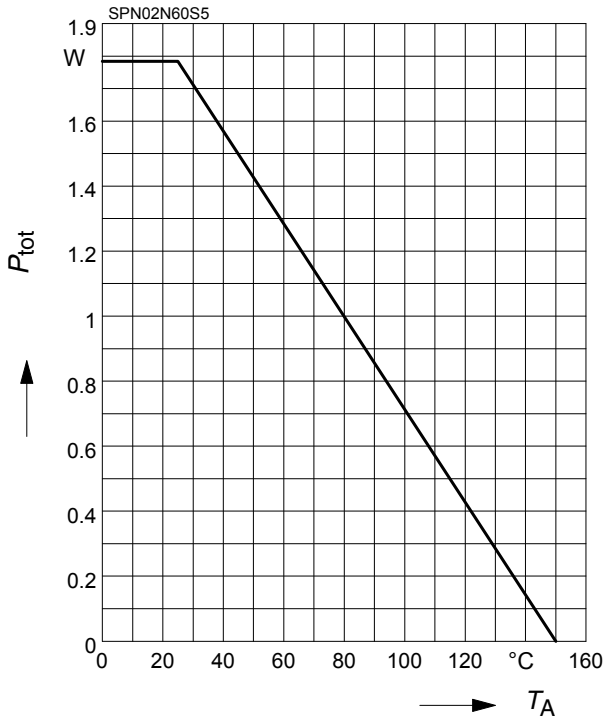

2 Safe operating area

$I_D = f(V_{DS})$

parameter : $D = 0, T_A = 25^\circ C$

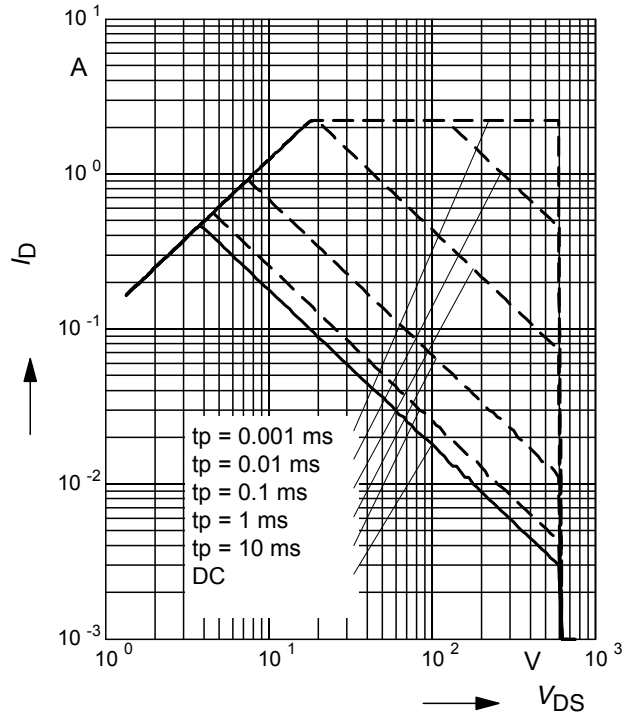

3 Transient thermal impedance

$Z_{thJC} = f(t_p)$

parameter: $D = t_p/T$

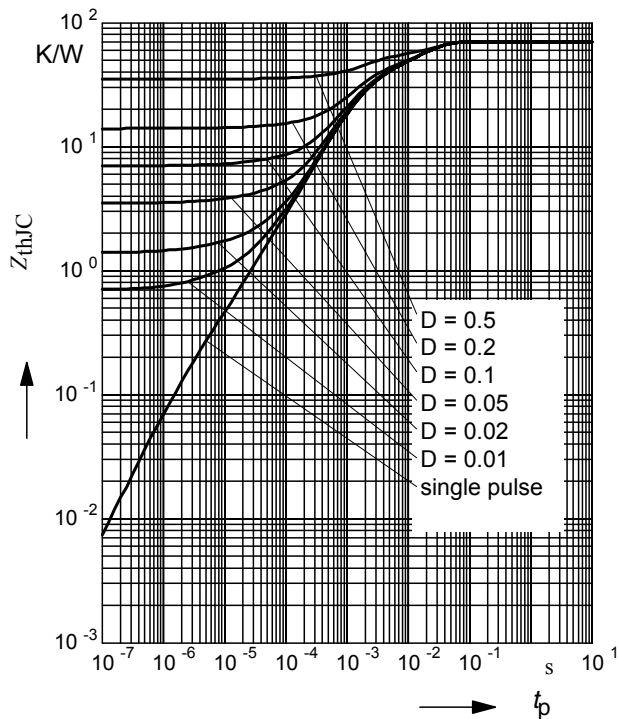

4 Typ. output characteristic

$I_D = f(V_{DS}); T_j = 25^\circ C$

parameter: $t_p = 10 \mu s, V_{GS}$

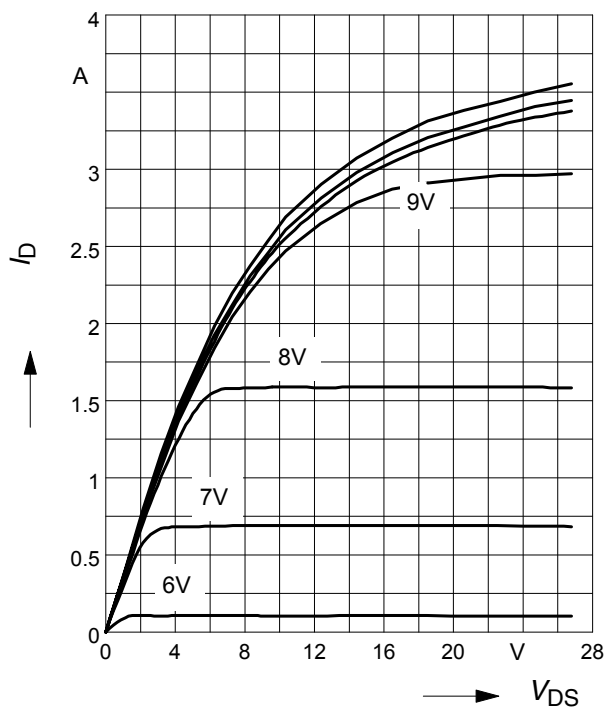

5 Drain-source on-state resistance

$$R_{DS(on)} = f(T_j)$$

parameter: $I_D = 0.3 \text{ A}$, $V_{GS} = 10 \text{ V}$

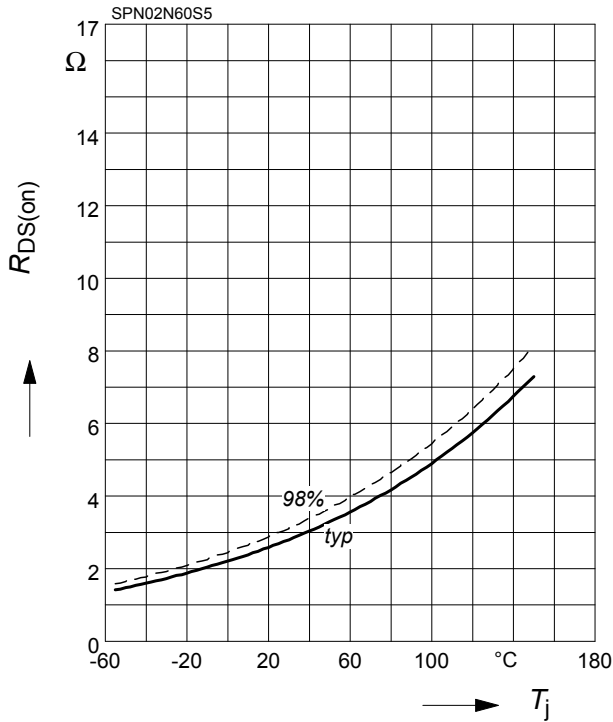

6 Typ. transfer characteristics

$$I_D = f(V_{GS}); V_{DS} \geq 2 \times I_D \times R_{DS(on)max}$$

parameter: $t_p = 10 \mu\text{s}$

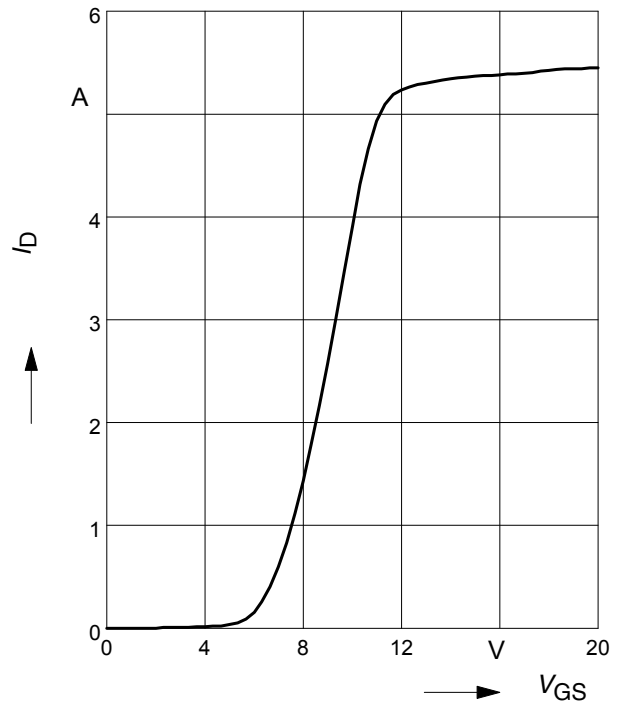

7 Typ. gate charge

$$V_{GS} = f(Q_{Gate})$$

parameter: $I_D = 0.4 \text{ A}$ pulsed

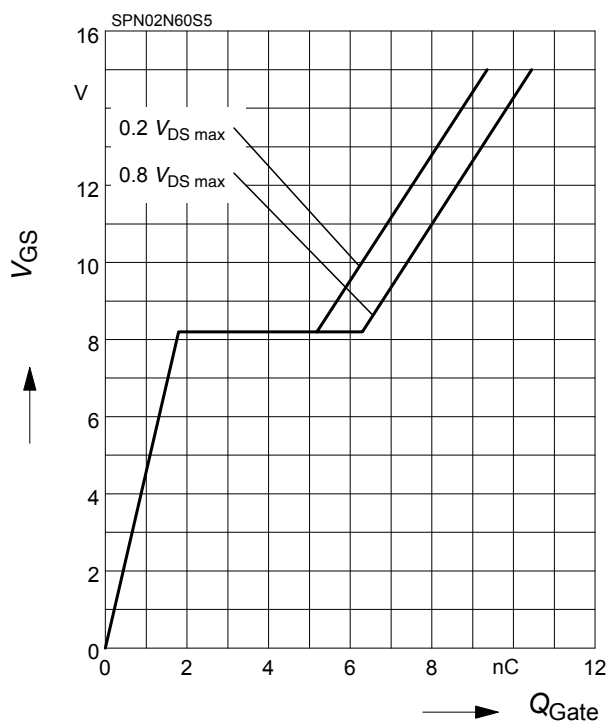

8 Forward characteristics of body diode

$$I_F = f(V_{SD})$$

parameter: T_j , $t_p = 10 \mu\text{s}$

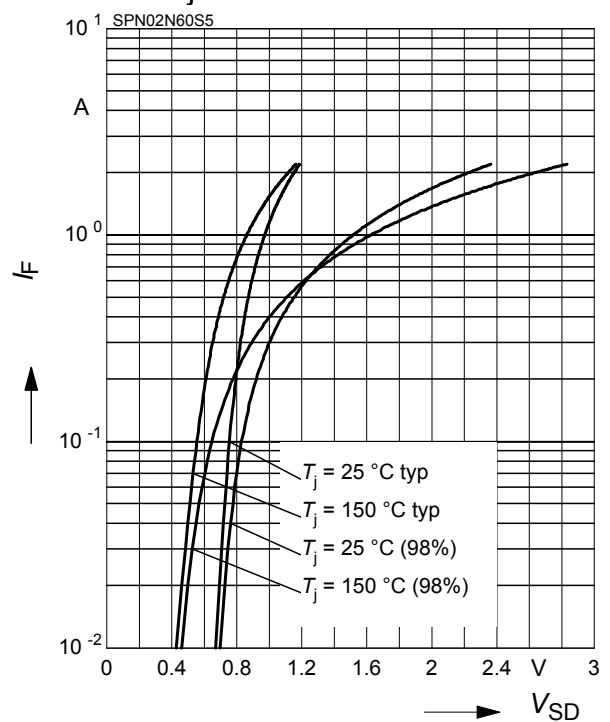

9 Drain-source breakdown voltage

$$V_{(BR)DSS} = f(T_j)$$

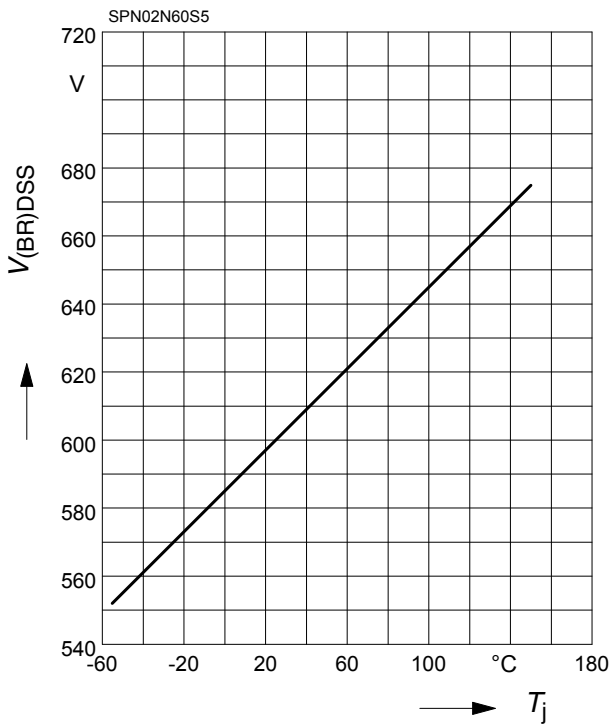

10 Typ. capacitances

$$C = f(V_{DS})$$

parameter: $V_{GS}=0V, f=1\text{ MHz}$

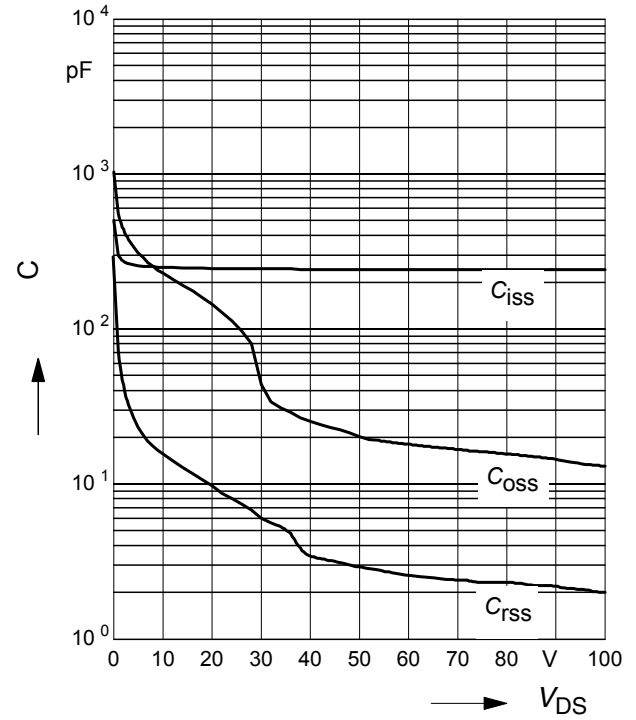

Definition of diodes switching characteristics

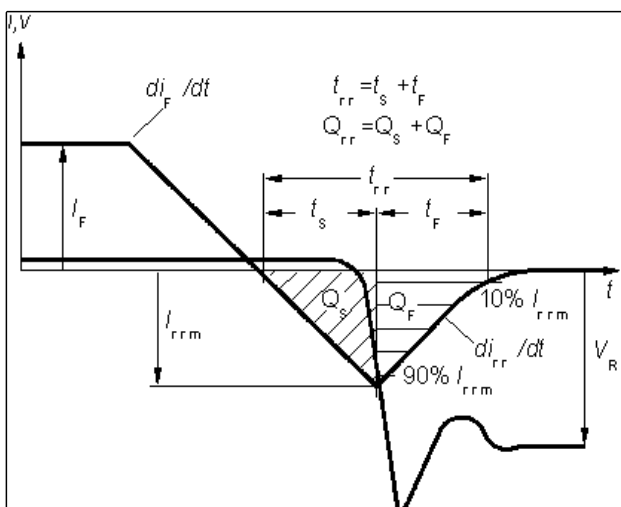

SOT223

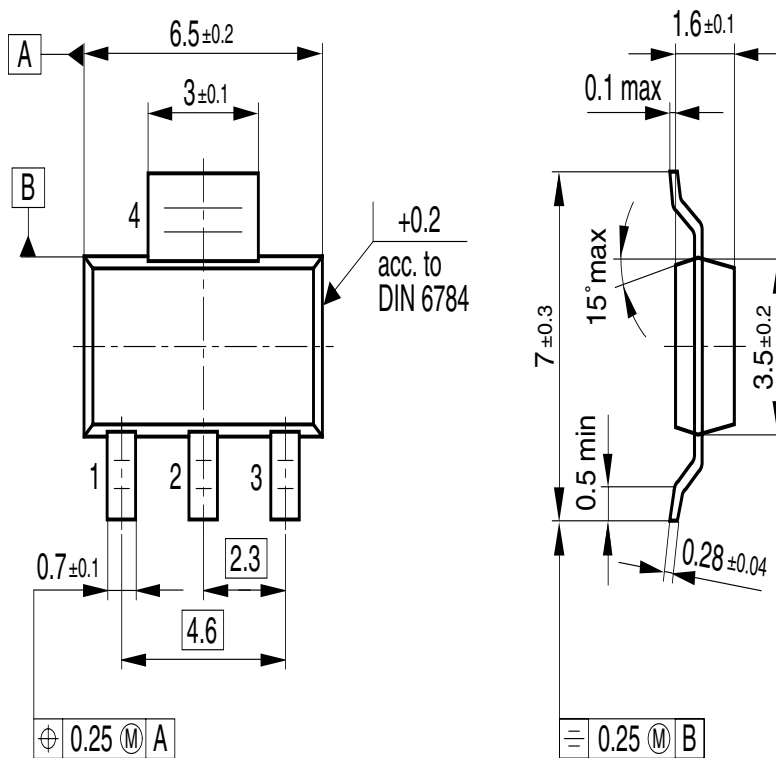

Published by
Infineon Technologies AG,
Bereichs Kommunikation
St.-Martin-Strasse 53,
D-81541 München
© Infineon Technologies AG 1999
All Rights Reserved.

Attention please!

The information herein is given to describe certain components and shall not be considered as warranted characteristics.

Terms of delivery and rights to technical change reserved.

We hereby disclaim any and all warranties, including but not limited to warranties of non-infringement, regarding circuits, descriptions and charts stated herein.

Infineon Technologies is an approved CECC manufacturer.

Information

For further information on technology, delivery terms and conditions and prices please contact your nearest Infineon Technologies Office in Germany or our Infineon Technologies Representatives worldwide (see address list).

Warnings

Due to technical requirements components may contain dangerous substances.

For information on the types in question please contact your nearest Infineon Technologies Office.

Infineon Technologies Components may only be used in life-support devices or systems with the express written approval of Infineon Technologies, if a failure of such components can reasonably be expected to cause the failure of that life-support device or system, or to affect the safety or effectiveness of that device or system. Life support devices or systems are intended to be implanted in the human body, or to support and/or maintain and sustain and/or protect human life. If they fail, it is reasonable to assume that the health of the user or other persons may be endangered.